

---

# PIVOT

---

## Ersatzteilkatalog

**RAVAK®**

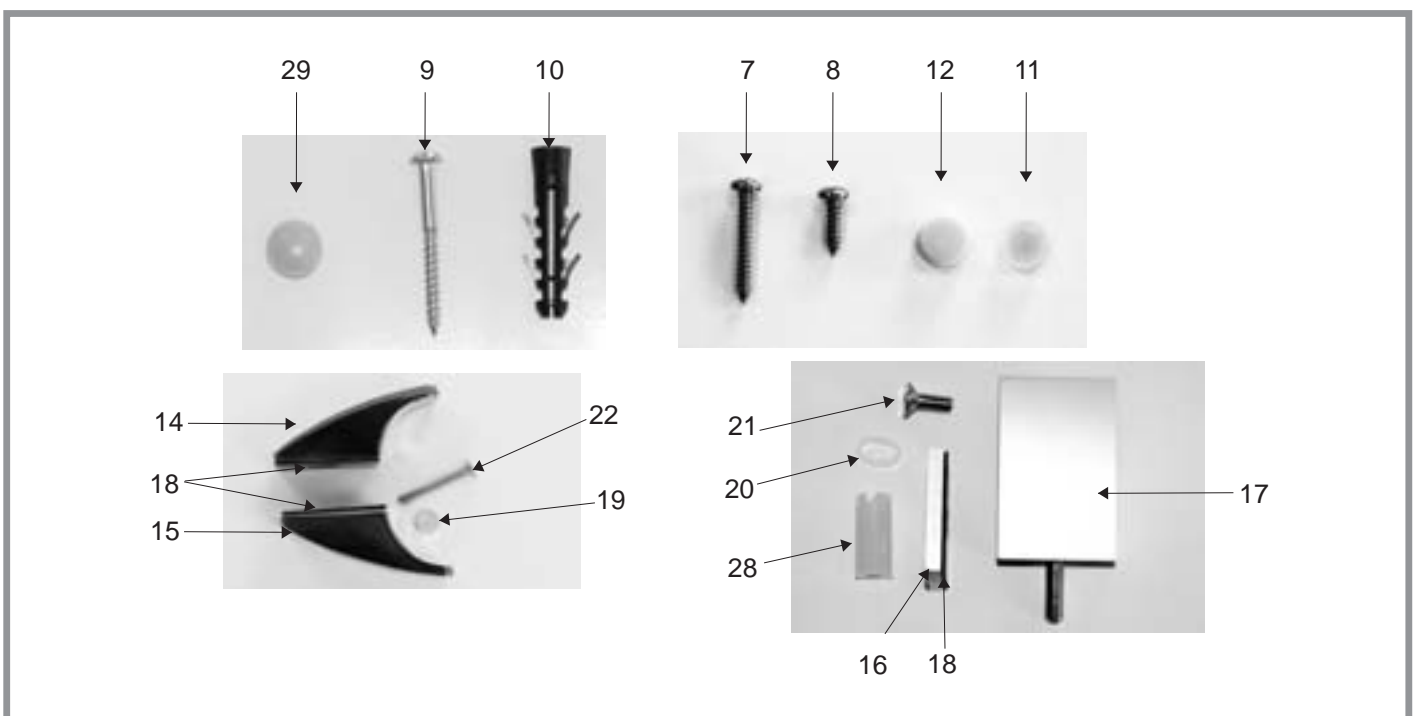
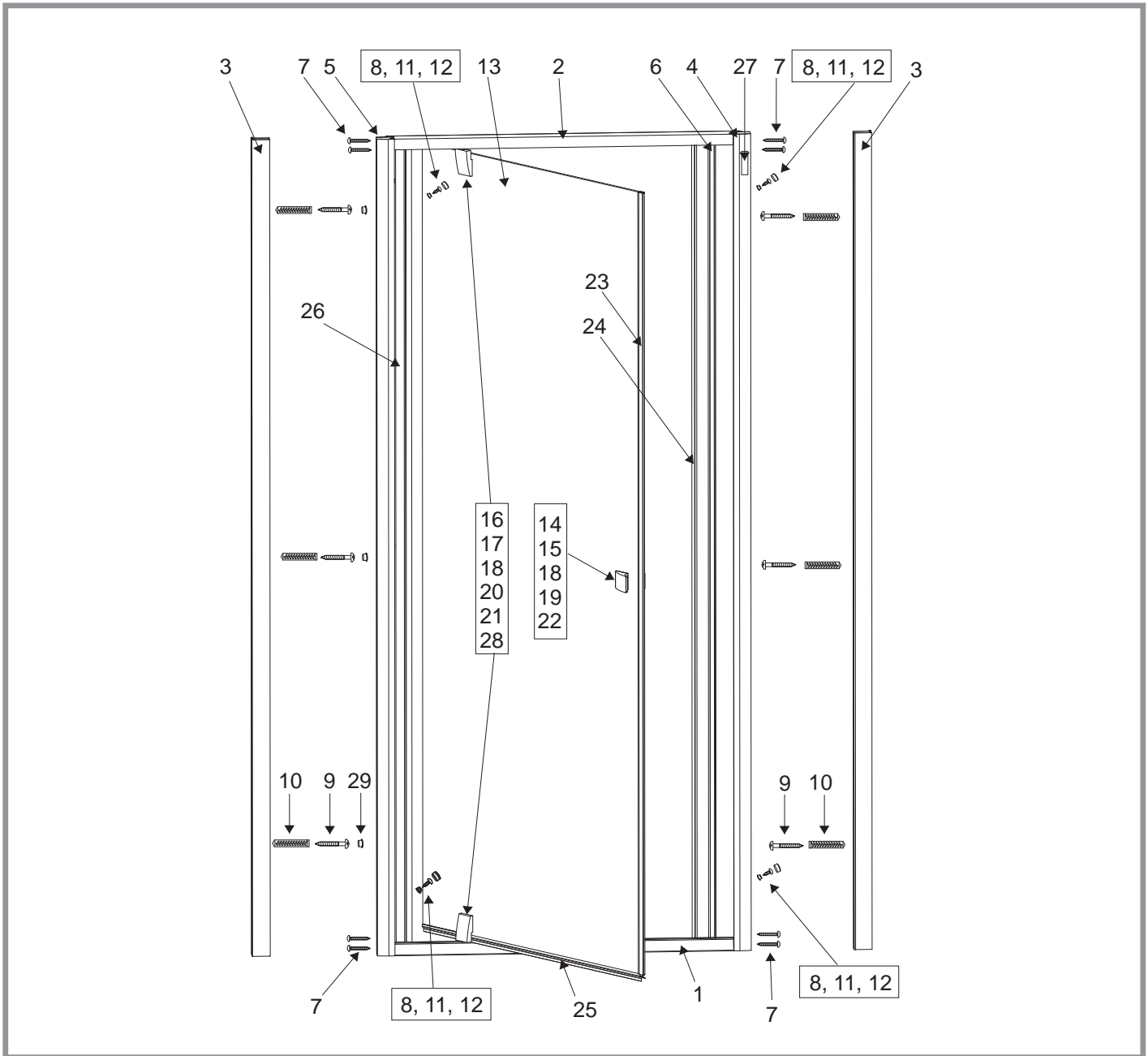

# PDOP1 - 80, PDOP1 - 90









# PDOP1 - 80, PDOP1 - 90





ET Nr.	Typ	Maße (mm)	Anzahl	ID / weiß	ID / elox	
1	Horizontalprofil rechts 12159/1	637	1 Stk. für PDOP1 - 80	XVC1590110673	XVC15901X0673	
1	Horizontalprofil rechts 12159/2	737	1 Stk. für PDOP1 - 90	XVC1590210773	XVC15902X0773	
2	Horizontalprofil links 12159/6	637	1 Stk. für PDOP1 - 80	XVC1590610673	XVC15906X0673	
2	Horizontalprofil links 12159/7	737	1 Stk. für PDOP1 - 90	XVC1590710773	XVC15907X0773	
3	Wandanschlussprofil 12216/1	1900	2 Stk.	XVC2160111900	XVC21601X1900	
4	Vertikalprofil 12213/2 4-Öffnungen	1900	1 Stk.	XVC2130211900	XVC21302X1900	
5	Vertikalprofil 12213/1 7-Öffnungen	1900	1 Stk.	XVC2130111900	XVC21301X1900	
6	Einlegenprofil vertikal 12214/1	1877	2 Stk.	XVC21401X1877	XVC21401X1877	
7	Schraube DIN 7981 A2	Ø 3,5 x 25	8 Stk.	X97981035250	X97981035250	
8	Schraube DIN 7981 A2	Ø 3,5 x 13	4 Stk.	X97981035130	X97981035130	
9	Dübelschraube	Ø 4 x 40	6 Stk.	X94000040400	X94000040400	
10	Dübel	Ø 8 für 4 x 40	6 Stk.	X20600080000	X20600080000	
11	Kunststoffscheibe106	Ø 10 x 4,5	4 Stk.	X8A600000000	X8A600000000	
12	Abdeckung 105 (Bohrung 3,5x13)	Ø 11,5 x 6	4 Stk.	X8A500000001	X8A500000000	
13	Glas - flach	636 x 1824	1 Stk. für PDOP1 - 80	X4Z160I246360	X4Z160I246360	
13	Glas - flach	736 x 1824	1 Stk. für PDOP1 - 90	X4Z160I247360	X4Z160I247360	
14	Griff außen		1 Stk.	Weiß X3PVV00700001 Chrom X3PVV00700000A	X3PVV0070000X	
15	Griff innen		1 Stk.	Weiß X3PVV00600001 Chrom X3PVV00600000A	X3PVV0060000X	
16	Torbandblech	38 x 38 x 5	2 Stk.	Weiß X3PVV01500001 Chrom X3PVV01500000A	X3PVV0150000X	
17	Scharnier mit Bolzen		2 Stk.	Weiß X3PVV01600001 Chrom X3PVV01600000A	X3PVV0160000X	
18	Federscheibe	37 x 37	6 Stk.	X3PVPR0010000	X3PVPR0010000	
19	Isolierschlauch transparent	Ø 5/7 - 5,5	1 Stk.	X80001075050	X80001075050	
20	Isolierschlauch transparent	Ø 10/12 - 6	2 Stk.	X3G020070000	X3G020070000	
21	Imbusschraube DIN 7991 rostfrei	M6 x 16	2 Stk.	X90991060160	X90991060160	
22	Schraube DIN 964 rostfrei	M4 x 30	1 Stk.	X90964040300	X90964040300	
23	Magnet SJ	1824	1 Stk.	X65622200013	X65622200013	
24	Magnet JS	1870	1 Stk.	X65623200014	X65623200014	
25	Abtropfleiste	636	1 Stk. für PDOP1 - 80	X65671500015	X65671500015	
25	Abtropfleiste	736	1 Stk. für PDOP1 - 90	X65671500016	X65671500016	
26	Fahnenleiste	1865	1 Stk.	X65672500012	X65672500012	



# PDOP1 - 80, PDOP1 - 90

ET Nr.	Typ	Maße (mm)	Anzahl	ID / weiß	ID / elox	
27	hologr. Logo RAVAK		1 Stk.	X21800000001	X21800000001	
28	Plastikgehäuse Pivot 134	Ø12 x 27	2 Stk.	X8D400000000	X8D400000000	
29	Kunststoffkappe 10/13mm	Ø10/13	3 Stk.	ZZ5300ZABI	ZZ5300ZASE	

Montagesatz PDOP1				D000001048	D00000A004	
9	Dübelschraube	Ø4 x 40	6 Stk.	X94000040400	X94000040400	
10	Dübel	Ø 8 für 4 x 40	6 Stk.	X20600080000	X20600080000	
29	Kunststoffkappe 10/13mm	10/13	3 Stk.	X80001100100	X80001100100	

Montageteile PDOP1				D000001049	D00000O003	
7	Schraube DIN 7981 A2	Ø 3,5 x 25	8 Stk.	X97981035250	X97981035250	
8	Schraube DIN 7981 A2	Ø 3,5 x 13	4 Stk.	X97981035130	X97981035130	
11	Kunststoffscheibe 106	Ø 10 x 4,5	4 Stk.	X8A600000000	X8A600000000	
12	Abdeckung 105 (Bohrung 3,5x13)	Ø 11,5 x 6	4 Stk.	X8A500000001	X8A500000000	

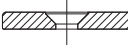





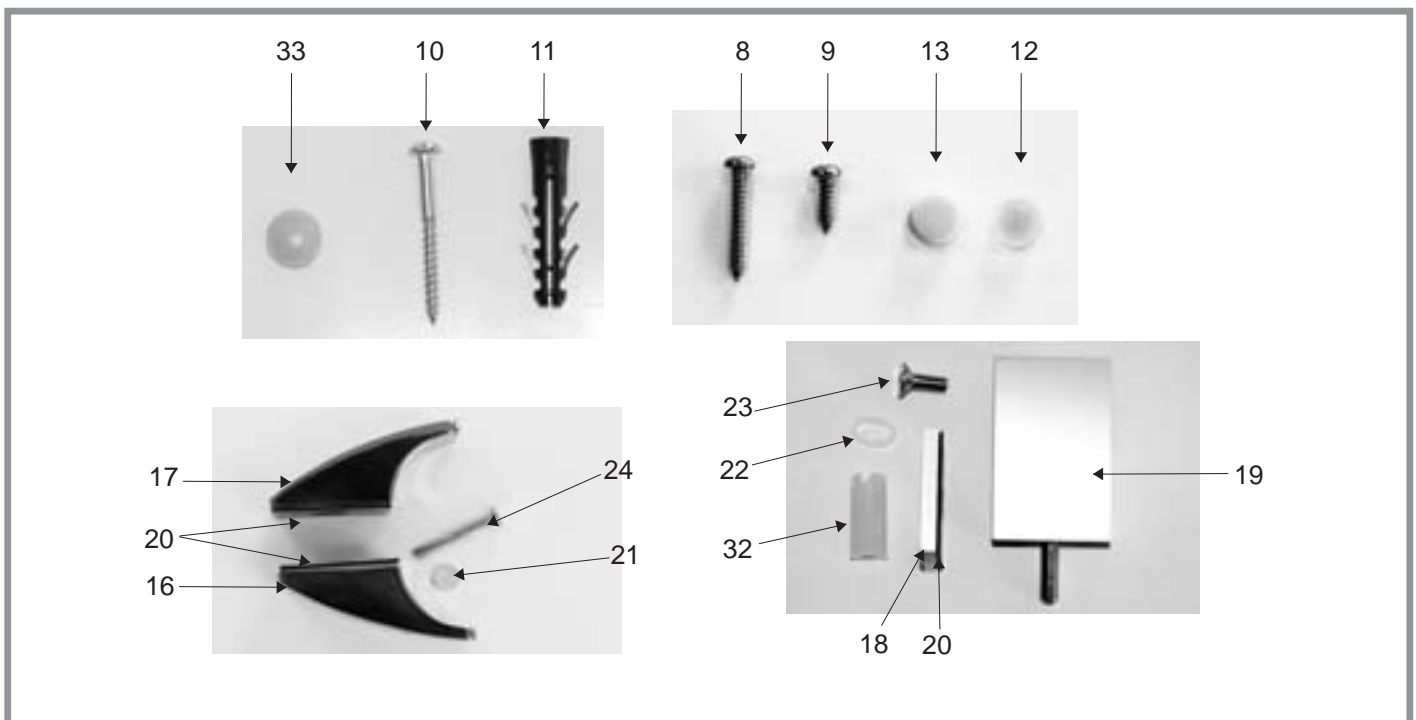
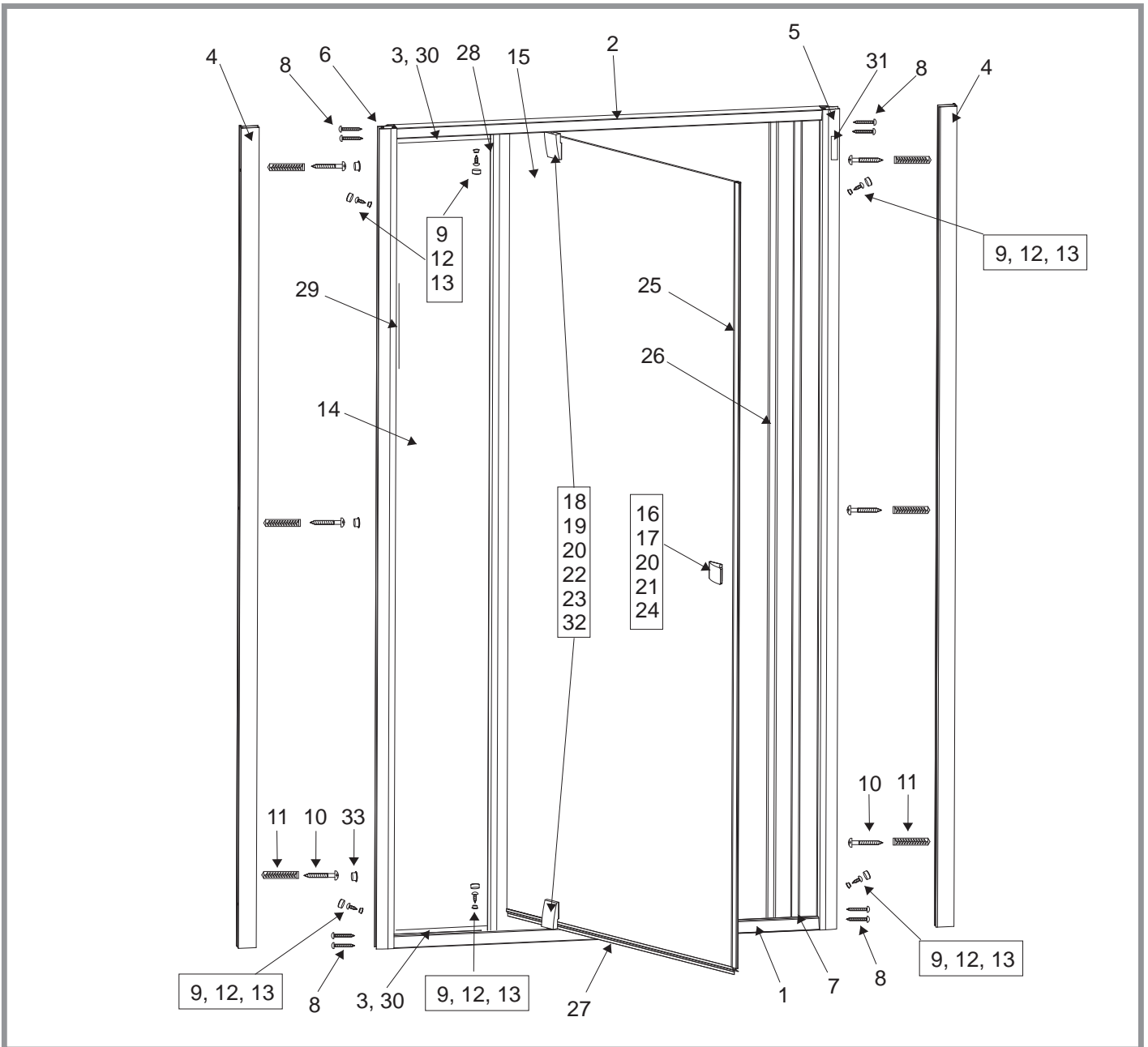









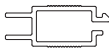



Montagesatz - Griffe				Weiß D000001001 Chrom D00000A002	D00000X001	
14	Griff außen		1 Stk.	Weiß X3PVV00700001 Chrom X3PVV0070000A	X3PVV0070000X	
15	Griff innen		1 Stk.	Weiß X3PVV00600001 Chrom X3PVV0060000A	X3PVV0060000X	
18	Federscheibe	37 x 37	2 Stk.	X3PVPR0010000	X3PVPR0010000	
19	Isolierschlauch transparent	Ø 5/7, 5-5	1 Stk.	X80001075050	X80001075050	
22	Schraube DIN 964 rostfrei	M4 x 30	1 Stk.	X90964040300	X90964040300	

Montagesatz - Scharniere				Weiß D000001052 Chrom D00000A003	D00000X002	
16	Torbandblech	38 x 38 x 5	2 Stk.	Weiß X3PVV01500001 Chrom X3PVV0150000A	X3PVV0150000A	
17	Scharnier mit Bolzen		2 Stk.	Weiß X3PVV01600001 Chrom X3PVV0160000A	X3PVV0160000X	
18	Federscheibe	37 x 37	4 Stk.	X3PVPR0010000	X3PVPR0010000	
20	Isolierschlauch transparent	Ø 10/12-6	2 Stk.	X3G20070000	X3G020070000	
21	Schraube DIN 7991 rostfrei	M6 x 16	2 Stk.	X90991060160	X90991060160	
28	Plastikgehäuse Pivot 134	Ø 12 x 27	2 Stk.	X8D000000000	X8D000000000	

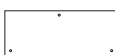

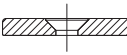
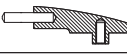







# PDOP2 - 100, PDOP2 - 110, PDOP2 - 120







## PDOP2 - 100, PDOP2 - 110, PDOP2 - 120





ET Nr.	Typ	Maße (mm)	Anzahl	ID / weiß	ID / elox	
1	Horizontalprofil rechts 12159/3	837	1 Stk. für PDOP2 - 100	XVC1590310873	XVC15903X0873	
1	Horizontalprofil rechts 12159/4	937	1 Stk. für PDOP2 - 110	XVC1590410973	XVC15904X0973	
1	Horizontalprofil rechts 12159/5	1037	1 Stk. für PDOP2 - 120	XVC1590511073	XVC15905X1073	
2	Horizontalprofil links 12159/8	837	1 Stk. für PDOP2 - 100	XVC1590810873	XVC15908X0873	
2	Horizontalprofil links 12159/9	937	1 Stk. für PDOP2 - 110	XVC1590910973	XVC15909X0973	
2	Horizontalprofil links 12159/10	1037	1 Stk. für PDOP2 - 120	XVC1591011073	XVC15910X1073	
3	Glasprofil RA-AL-009/51	220	2 Stk. für PDOP2 - 100/110	XVRA095110220	XVRA0951X0220	
3	Glasprofil RA-AL-009/52	320	2 Stk. für PDOP2 - 120	XVRA095210320	XVRA0952X0320	
4	Wandanschlussprofil 12216/1	1900	2 Stk.	XVC2160111900	XVC21601X1900	
5	Vertikalprofil 12213/2 4-Öffnungen	1900	1 Stk.	XVC2130211900	XVC21302X1900	
6	Vertikalprofil 12213/2 7-Öffnungen	1900	1 Stk.	XVC2130111900	XVC21301X1900	
7	Vertikalprofil 12214 /1	1877	1 Stk.	XVC21401X1877	XVC21401X1877	
8	Schraube DIN 7981 A2	Ø 3,5 x 25	8 Stk.	X97981035250	X97981035250	
9	Schraube DIN 7981 A2	Ø 3,5 x 13	6 Stk.	X97981035130	X97981035130	
10	Dübelschraube	Ø 4 x 40	6 Stk.	X94000040400	X94000040400	
11	Dübel	Ø 8 für 4 x 40	6 Stk.	X20600080000	X20600080000	
12	Kunststoffscheibe 106	Ø 10 x 4,5	6 Stk.	X8A600000000	X8A600000000	
13	Abdeckung 105 (Bohrung 3,5x13)	Ø 11,5 x 6	6 Stk.	X8A500000001	X8A500000000	
14	Glas PS - flach (ohne Löcher)	216 x 1870	1 Stk. für PDOP2 - 100/110	X4Z160I702160	X4Z160I702160	
14	Glas PS - flach (ohne Löcher)	316 x 1870	1 Stk. für PDOP2 - 120	X4Z160I703160	X4Z160I703160	
15	Glas - flach	636 x 1824	1 Stk. für PDOP2 - 100	X4Z160I246360	X4Z160I246360	
15	Glas - flach	736 x 1824	1 Stk. für PDOP2 - 110/120	X4Z160I247360	X4Z160I247360	
16	Griff außen		1 Stk.	Weiß X3PVV00700001 Chrom X3PVV0070000A	X3PVV0070000X	
17	Griff innen		1 Stk.	Weiß X3PVV00600001 Chrom X3PVV0060000A	X3PVV0060000X	
18	Torbandblech	38 x 38 x 5	2 Stk.	Weiß X3PVV01500001 Chrom X3PVV0150000A	X3PVV0150000X	
19	Scharnier mit Bolzen		2 Stk.	Weiß X3PVV01600001 Chrom X3PVV0160000A	X3PVV0160000X	
20	Federscheibe	37 x 37	6 Stk.	X3PVPR0010000	X3PVPR0010000	
21	Isolierschlauch transparent	Ø 5/7 x 5,5	1 Stk.	X80001075050	X80001075050	
22	Isolierschlauch transparent	Ø 10/12 - 6	2 Stk.	X3G020070000	X3G020070000	

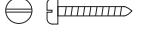
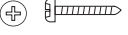



## PDOP2 - 100, PDOP2 - 110, PDOP2 - 120

ET Nr.		Maße (mm)	Anzahl	ID / weiß	ID / elox	
23	Imbusschraube DIN 7991 rostfrei	M6x16	2 Stk.	X90991060160	X90991060160	
24	Schraube DIN 964 rostfrei	M4x30	1 Stk.	X90964040300	X90964040300	
25	Magnet SJ	1824	1 Stk.	X65622200013	X65622200013	
26	Magnet JS	1870	2 Stk.	X65623200014	X65623200014	
27	Abtropfleiste	636	1 Stk. für PDOP2 - 100	X65671500015	X65671500015	
27	Abtropfleiste	736	1 Stk. für PDOP2 - 110/120	X65671500016	X65671500016	
28	Fahnenleiste	1865	1 Stk.	X65671500016	X65672500012	
29	Glasprofil Nr. 90 - vertikal	1870	1 Stk.	X89000000000	X89000000000	
30	Glasprofil Nr. 111 - horizontal	200	2 Stk. für PDOP2 - 100/110	X8B100000000	X8B100000000	
30	Glasprofil Nr. 111 - horizontal	300	2 Stk. für PDOP2 - 120	X8B100000000	X8B100000000	
31	hologr. Logo RAVAK		1 Stk.	X21800000001	X21800000001	
32	Plastikgehäuse Pivot 134	Ø 12 x 27	2 Stk.	X8D400000000	X8D400000000	
33	Kunststoffkappe 10/13mm		3 Stk.	ZZ5300ZABI	ZZ5300ZASE	

Montagesatz PDOP2				D000001048	D00000A004	
10	Dübelschraube	4 x 40	6 Stk.	X94000040400	X94000040400	
11	Dübel	Ø 8 für 4 x 40	6 Stk.	X20600080000	X20600080000	
33	Kunststoffkappe	10/13	3 Stk.	X80001100100	X80001100100	

Montageteile PDOP2				D000001050	D00000O004	
8	Schraube DIN 7981 A2	Ø 3,5 x 25	8 Stk.	X97981035250	X97981035250	
9	Schraube DIN 7981 A2	Ø 3,5 x 13	6 Stk.	X97981035130	X97981035130	
12	Kunststoffscheibe 106	Ø 10 x 4,5	6 Stk.	X8A600000000	X8A600000000	
13	Abdeckung 105 (Bohrung 3,5x13)	Ø 11,5 x 6	6 Stk.	X8A500000001	X8A500000000	

ET Nr.	Typ	Maße (mm)	Anzahl	ID / weiß	ID / elox	
<b>Montagesatz - Griffe</b>				<b>Weiß D000001001 Chrom D00000A002</b>	<b>D00000X001</b>	
16	Griff außen		1 Stk.	Weiß X3PVV00700001 Chrom X3PVV0070000A	X3PVV0070000X	
17	Griff innen		1 Stk.	Weiß X3PVV00600001 Chrom X3PVV0060000A	X3PVV0060000X	
20	Federscheibe	37 x 37	2 Stk.	X3PVPR0010000	X3PVPR0010000	
21	Isolierschlauch transparent	Ø 5/7, 5-5	1 Stk.	X80001075050	X80001075050	
24	Schraube DIN 964 rostfrei	M4 x 30	1 Stk.	X90964040300	X90964040300	

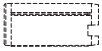



<b>Montagesatz - Scharniere</b>				<b>Weiß D000001052 Chrom D00000A003</b>	<b>D00000X002</b>	
18	Scharnier mit Bolzen		2 Stk.	Weiß X3PVV01600001 Chrom X3PVV0160000A	X3PVV0160000X	
19	Torbandblech	38 x 38 x 5	2 Stk.	Weiß X3PVV01500001 Chrom X3PVV0150000A	X3PVV0150000A	
20	Federscheibe	37 x 37	4 Stk.	X3PVPR0010000	X3PVPR0010000	
22	Isolierschlauch transparent	Ø 10/12-6	2 Stk.	X3G20070000	X3G020070000	
23	Schraube DIN 7991 rostfrei	M6 x 16	2 Stk.	X90991060160	X90991060160	
32	Plastikgehäuse Pivot 134	Ø 12x27	2 Stk.	X8D00000000	X8D00000000	

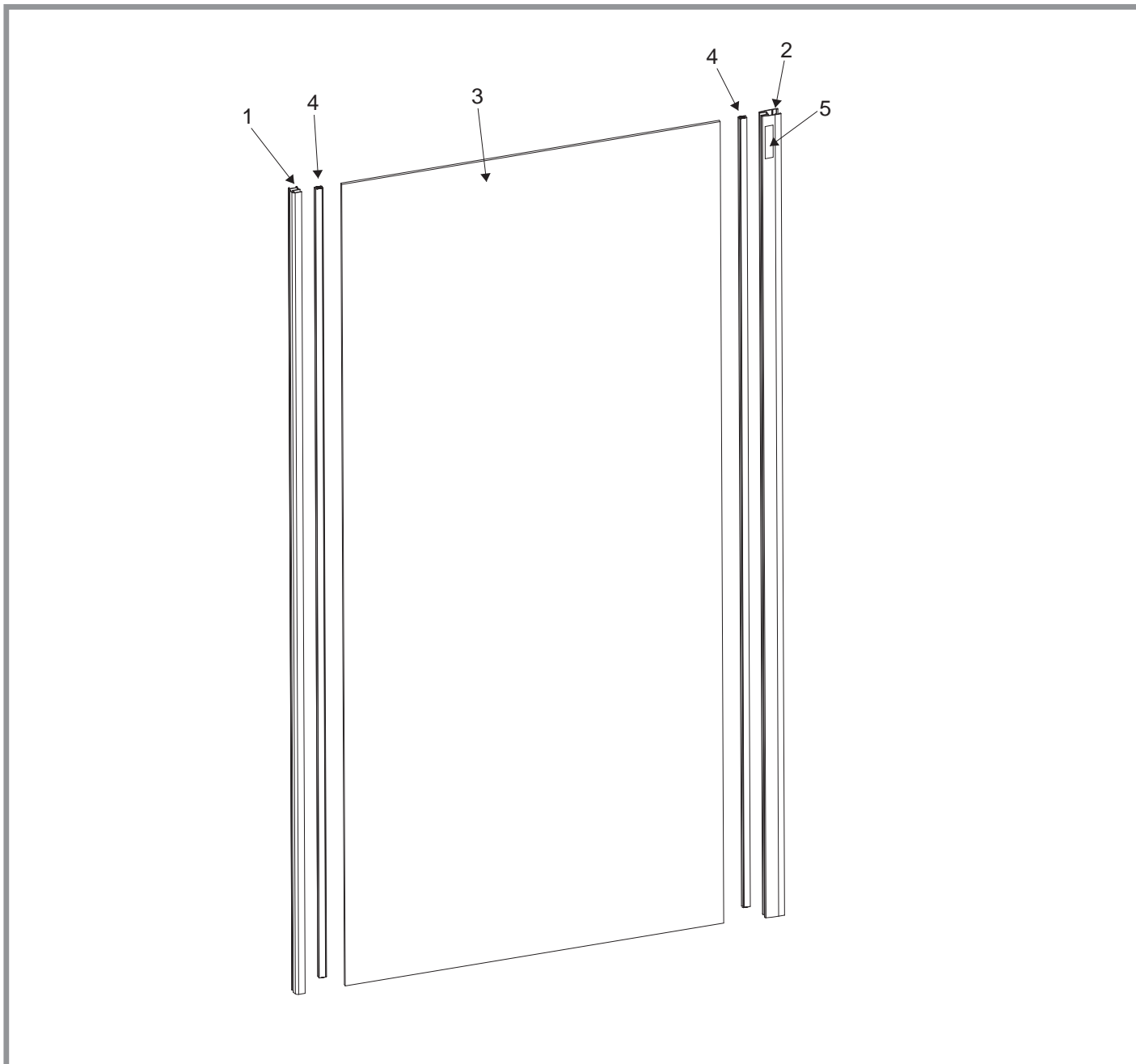

## PPS - 80, PPS - 90, PPS - 100









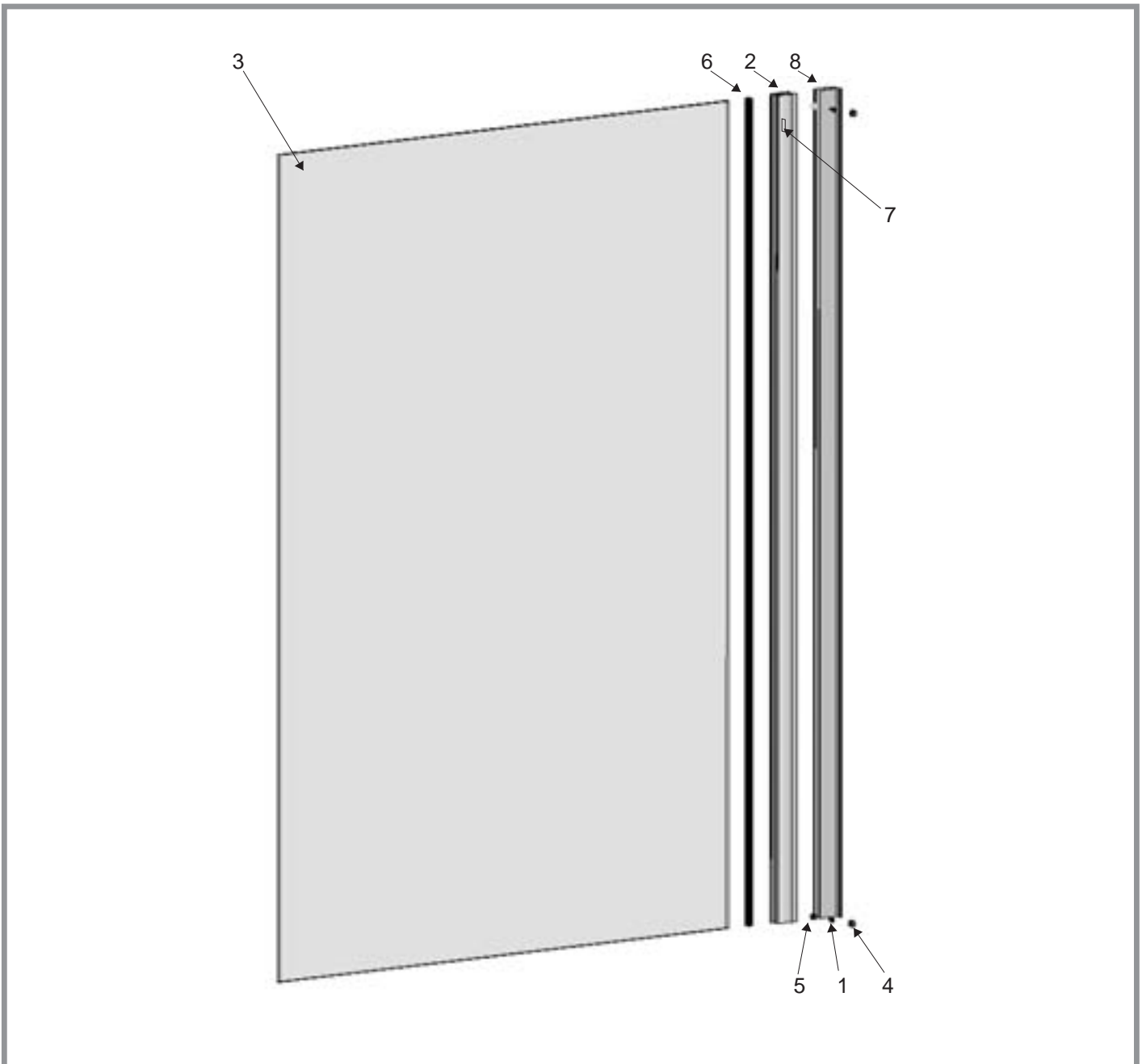

## PPS - 80, PPS - 90, PPS - 100

ET Nr.	Typ	Maße (mm)	Anzahl	ID / weiß	ID / elox	
1	Vertikalprofil 12217/1 - zur Ecke	1900	1 Stk.	XVC2170111900	XVC21701X1900	
2	Vertikalprofil 12215/1 - zur Wand	1900	1 Stk.	XVC2150111900	XVC21501X1900	
3	Glas PS - flach (ohne Löcher)	723 x 1900	1 Stk. für PPS - 80	X4Z160J007230	X4Z160J007230	
3	Glas PS - flach (ohne Löcher)	832 x 1900	1 Stk. für PPS - 90	X4Z160J008230	X4Z160J008230	
3	Glas PS - flach (ohne Löcher)	923 x 1900	1 Stk. für PPS - 100	X4Z160J009230	X4Z160J009230	
4	Glasprofil Nr. 90 - vertikal	1900	2 Stk.	X89000000000	X89000000000	
5	hologr. Logo RAVAK		1 Stk.	X21800000001	X21800000001	

# PVS1 - 80







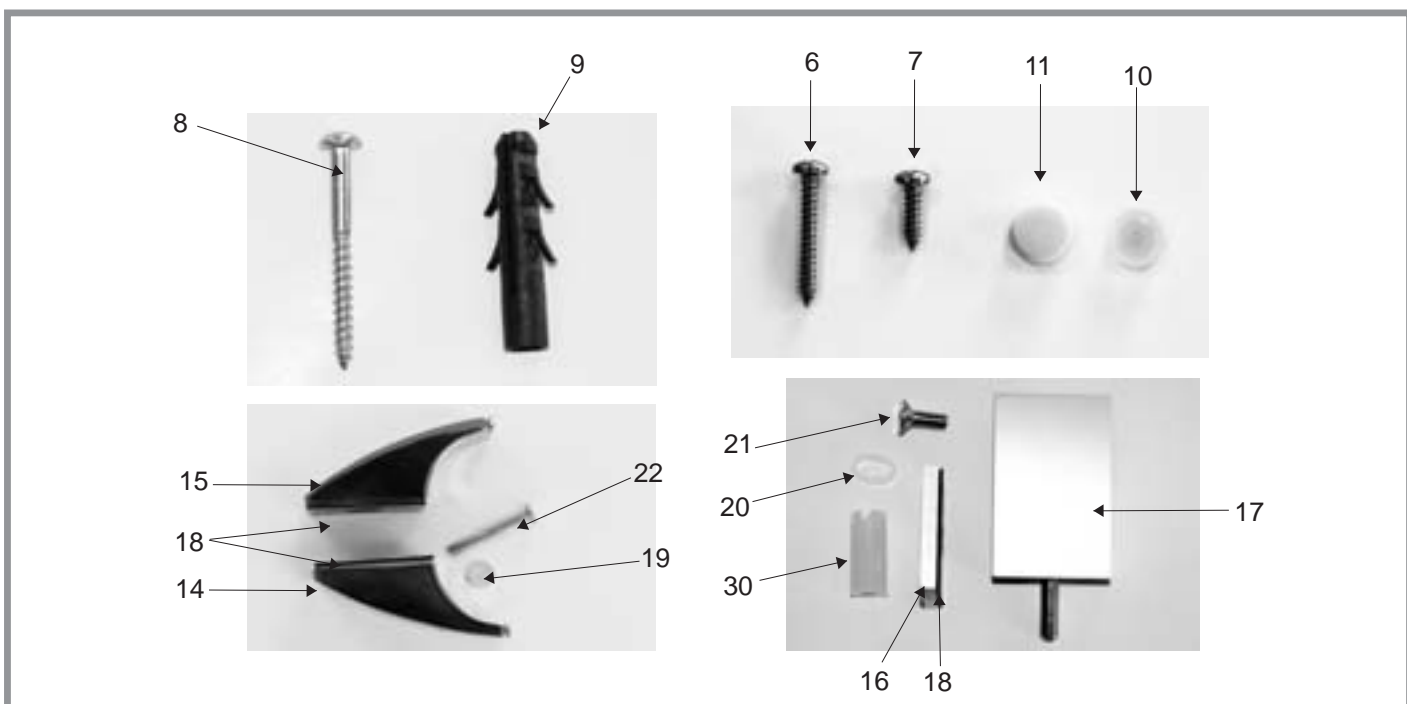
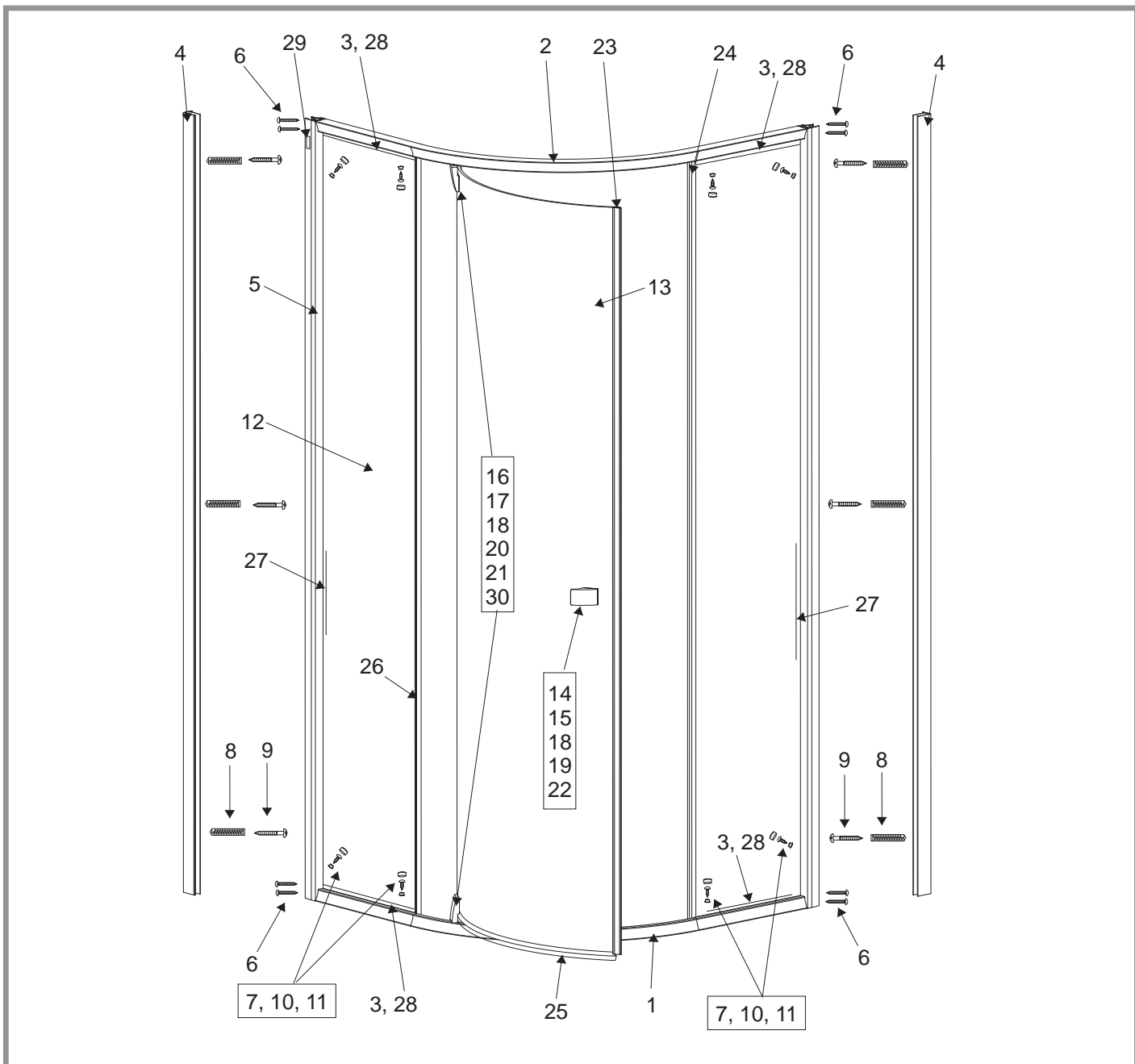







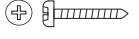





ET Nr.	Typ	Maße (mm)	Anzahl	ID / weiß	ID / elox	
1	Schraube DIN 7981 A2	Ø3,5 x 13	2 Stk.	X97981035130	X97981035130	
2	Vertikalprofil 12215/02	1400	1 Stk.	XVC2150211400	XVC21502X1400	
3	Glas PS (ohne Löcher)	767 x 1400	1 Stk.	X4Z160J007230	X4Z160J007230	
4	Abdeckung 105	Ø11,4 x 5,5	2 Stk.	X8A500000001	X8A500000001	
5	Kunststoffscheibe 106	Ø10 x 4,5	2 Stk.	X8A600000000	X8A600000000	
6	Glasprofil 111 CB Transparent	1400	1 Stk.	X8B100000000	X8B100000000	
7	hologr. Logo RAVAK		1 Stk.	X21800000001	X8B100000000	
8	Wandanschlussprofil 12216/02	1400	1 Stk.	XWC2160211400	XWC21602X1400	



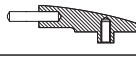

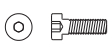

# PSKK3 - 80, PSKK3 - 90, PSKK3 - 100







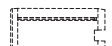

## PSKK3 - 80, PSKK3 - 90, PSKK3 - 100





ET Nr.	Typ	Maße (mm)	Anzahl	ID / weiß	ID / elox	
1	Horizontalprofil rechts 12159/14	1244	1 Stk. für PSKK3 - 80	XVC1591411244	XVC15914X1244	
1	Horizontalprofil rechts 12159/15	1444	1 Stk. für PSKK3 - 90	XVC1591511444	XVC15915X1444	
1	Horizontalprofil rechts 12159/16	1644	1 Stk. für PSKK3 - 100	XVC1591611644	XVC15916X1644	
2	Horizontalprofil rechts 12159/17	1244	1 Stk. für PSKK3 - 80	XVC1591711244	XVC15917X1244	
2	Horizontalprofil rechts 12159/18	1444	1 Stk. für PSKK3 - 90	XVC1591811444	XVC15918X1444	
2	Horizontalprofil rechts 12159/19	1644	1 Stk. für PSKK3 - 100	XVC1591911644	XVC15919X1644	
3	Glasprofil RA-AL-009/53	251	4 Stk. für PSKK3 - 80	XVRA095310251	XVRA0953X0251	
3	Glasprofil RA-AL-009/54	351	4 Stk. für PSKK3 - 90	XVRA095410351	XVRA0954X0351	
3	Glasprofil RA-AL-009/55	451	4 Stk. für PSKK3 - 100	XVRA095510451	XVRA0955X0451	
4	Wandanschlussprofil 12216/1	1900	2 Stk.	XVC2160111900	XVC21601X1900	
5	Vertikalprofil 12213/2 4-Öffnungen	1900	2 Stk.	XVC2130211900	XVC21302X1900	
6	Schraube DIN 7981 A2	Ø 3,5 x 25	8 Stk.	X97981035250	X97981035250	
7	Schraube DIN 7981 A2	Ø 3,5 x 13	8 Stk.	X97981035130	X97981035130	
8	Dübelschraube	Ø 4 x 40	6 Stk.	X94000040400	X94000040400	
9	Dübel	Ø 8 für 4 x 40	6 Stk.	X20600080000	X20600080000	
10	Kunststoffscheibe 106	Ø 10 x 4,5	8 Stk.	X8A600000000	X8A600000000	
11	Abdeckung 105 (Bohrung 3,5x13)	Ø 11,5 x 6	8 Stk.	X8A500000001	X8A500000000	
12	Glas PS - flach	247 x 1870	2 Stk. für PSKK3 - 80	X4Z60I702470	X4Z60I702470	
12	Glas PS - flach	347 x 1870	2 Stk. für PSKK3 - 90	X4Z60I703470	X4Z60I703470	
12	Glas PS - flach	447 x 1870	2 Stk. für PSKK3 - 100	X4Z60I704470	X4Z60I704470	
13	Glas - gebogen	702 x 1824	1 Stk.	X4Y60I24702B	X4Y60I24702B	
14	Griff außen		1 Stk.	Weiß X3PVV00700001 Chrom X3PVV0070000A	X3PVV0070000X	
15	Griff innen		1 Stk.	Weiß X3PVV00600001 Chrom X3PVV0060000A	X3PVV0060000X	
16	Torbandblech	38 x 38 x 5	2 Stk.	Weiß X3PVV01500001 Chrom X3PVV0150000A	X3PVV0150000X	
17	Scharnier mit Bolzen		2 Stk.	Weiß X3PVV01600001 Chrom X3PVV0160000A	X3PVV0160000X	
18	Federscheibe	37 x 37	6 Stk.	X3PVPR0010000	X3PVPR0010000	
19	Isolierschlauch transparent	Ø 5/7 - 5,5	1 Stk.	X80001075050	X80001075050	
20	Isolierschlauch transparent	Ø 10/12 - 6	2 Stk.	X65671500015	X65671500015	
21	Imbusschraube DIN 7991 rostfrei	M6 x 16	2 Stk.	X90991060160	X90991060160	







## PSKK3 - 80, PSKK3 - 90, PSKK3 - 100

ET Nr.	Typ	Maße (mm)	Anzahl	ID / weiß	ID / elox	
22	Schraube DIN 964 mm	M4x30	1 Stk.	X90964040300	X90964040300	
23	Magnet SJ	1824	1 Stk.	X65622200013	X65622200013	
24	Magnet JS	1870	1 Stk.	X65623200014	X65623200014	
25	Abtropfleiste	702	1 Stk.	X65671500017	X65671500017	
26	Fahnenleiste	1865	1 Stk.	X65671500016	X65672500012	
27	Glasprofil Nr. 90 - vertikal	1870	2 Stk.	X89000000000	X89000000000	
28	Glasprofil Nr. 111 - horizontal	234	4 Stk. für PSKK3 - 80	X8B100000000	X8B100000000	
28	Glasprofil Nr. 111 - horizontal	334	4 Stk. für PSKK3 - 90	X8B100000000	X8B100000000	
28	Glasprofil Nr. 111 - horizontal	434	4 Stk. für PSKK3 - 100	X8B100000000	X8B100000000	
29	hologr. Logo RAVAK		1 Stk.	X21800000001	X21800000001	
30	Plastikgehäuse Pivot 134	Ø 12 x 27	2 Stk.	X8D400000000	X8D400000000	

Montagesatz PSKK3				D00000009	D00000009	
8	Dübelschraube	Ø4 x 40	6 Stk.	X94000040400	X94000040400	
9	Dübel	Ø 8 für 4 x 40	6 Stk.	X20600080000	X20600080000	

Montageteile PSKK3				D000001051	D000000005	
6	Schraube DIN 7981 A2	Ø 3,5 x 25	8 Stk.	X97981035250	X97981035250	
7	Schraube DIN 7981 A2	Ø 3,5 x 13	8 Stk.	X97981035130	X97981035130	
10	Kunststoffscheibe 106	Ø 10 x 4,5	8 Stk.	X8A600000000	X8A600000000	
11	Abdeckung 105 (Bohrung 3,5x13)	Ø 11,5 x 6	8 Stk.	X8A500000001	X8A500000000	

Montagesatz - Griffe				Weiß D000001001 Chrom D00000A002	D00000X001	
14	Griff außen		1 Stk.	Weiß X3PVV00700001 Chrom X3PVV0070000A	X3PVV0070000X	
15	Griff innen		1 Stk.	Weiß X3PVV00600001 Chrom X3PVV0060000A	X3PVV0060000X	
18	Federscheibe	37 x 37	2 Stk.	X3PVP0010000	X3PVP0010000	
19	Isolierschlauch transparent	Ø 5/7, 5-5	1 Stk.	X80001075050	X80001075050	
22	Schraube DIN 964 rostfrei	M4 x 30	1 Stk.	X90964040300	X90964040300	

ET Nr.	Typ	Maße (mm)	Anzahl	ID / weiß	ID / elox	
<b>Montagesatz - Scharniere</b>				<b>Weiß D000001052</b> <b>Chrom D00000A003</b>	<b>D00000X002</b>	
16	Torbandblech	38 x 38 x 5	2 Stk.	Weiß X3PVV01500001 Chrom X3PVV0150000A	X3PVV0150000A	
17	Scharnier mit Bolzen		2 Stk.	Weiß X3PVV01600001 Chrom X3PVV0160000A	X3PVV0160000X	
18	Federscheibe	37 x 37	4 Stk.	X3PVPR0010000	X3PVPR0010000	
20	Isolierschlauch transparent	Ø 10/12-6	2 Stk.	X3G20070000	X3G020070000	
21	Imbusschraube DIN 7991 rostfrei	M6 x 16	2 Stk.	X90991060160	X90991060160	
30	Plastikgehäuse Pivot 134	Ø 12x 5	2 Stk.	X8D00000000	X8D00000000	



# **RAVAK<sup>®</sup>**

**RAVAK SLOVAKIA spol. s r.o.**, Einsteinova 11, 851 01 Bratislava  
Tel.: 02 444 550 01, Fax: 02 444 550 02, E-mail: [obchod@ravak.sk](mailto:obchod@ravak.sk), [www.ravak.sk](http://www.ravak.sk)

**RAVAK Vertrieb Österreich**, Ufergasse 56, A3500 Krems, Österreich  
Tel.: 0043 676 / 731 2206, Fax: 0043 2742 / 222 333 2743, E-Mail: [office@ravak.at](mailto:office@ravak.at)